

RF & MICROWAVE TRANSISTORS UHF TV/LINEAR APPLICATIONS

- 860 MHz
- 25 VOLTS
- COMMON EMITTER
- GOLD METALLIZATION
- CLASS A LINEAR OPERATION
- P_{OUT} = 4.0 W MIN. WITH 7.0 dB GAIN

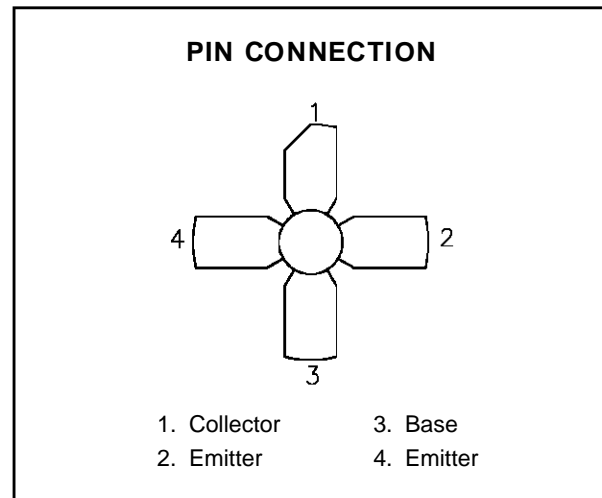
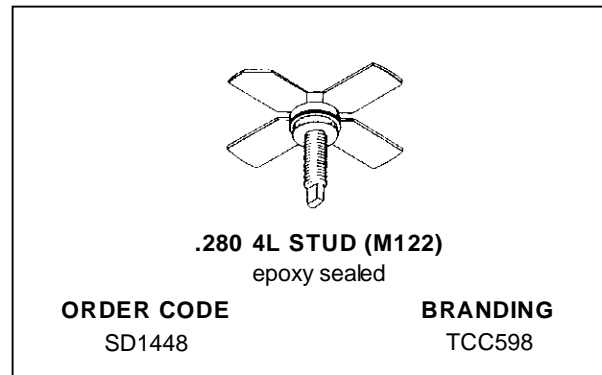

DESCRIPTION

The SD1448 is a silicon NPN bipolar device specifically designed for high linearity applications in the UHF frequency range including TV Bands IV and V.

Gold metallization and emitter ballasting assure high reliability under Class A linear amplifier operation.

ABSOLUTE MAXIMUM RATINGS (T_{case} = 25°C)

Symbol	Parameter	Value	Unit
V _{CBO}	Collector-Base Voltage	45	V
V _{CEO}	Collector-Emitter Voltage	25	V
V _{EBO}	Emitter-Base Voltage	4	V
I _C	Device Current	1.6	A
P _{DISS}	Power Dissipation	31.8	W
T _J	Junction Temperature	+200	°C
T _{STG}	Storage Temperature	- 65 to +150	°C

THERMAL DATA

R _{TH(j-c)}	Junction-Case Thermal Resistance	5.5	°C/W
----------------------	----------------------------------	-----	------

SD1448 (TCC598)

ELECTRICAL SPECIFICATIONS ($T_{\text{case}} = 25^{\circ}\text{C}$)

STATIC

Symbol	Test Conditions		Value			Unit
			Min.	Typ.	Max.	
BV_{CBO}	$I_{\text{C}} = 10\text{mA}$	$I_{\text{E}} = 0\text{mA}$	45	—	—	V
BV_{CEO}	$I_{\text{C}} = 20\text{mA}$	$I_{\text{B}} = 0\text{mA}$	25	—	—	V
BV_{EBO}	$I_{\text{E}} = 2.5\text{mA}$	$I_{\text{C}} = 0\text{mA}$	3.0	—	—	V
I_{CBO}	$V_{\text{CB}} = 28\text{V}$	$I_{\text{E}} = 0\text{mA}$	—	—	0.9	mA
h_{FE}	$V_{\text{CE}} = 20\text{V}$	$I_{\text{C}} = 500\text{mA}$	10	—	—	—

DYNAMIC

Symbol	Test Conditions			Value			Unit
				Min.	Typ.	Max.	
P_{OUT}^1	$f = 860\text{ MHz}$	$V_{\text{CE}} = 25\text{ V}$	$I_{\text{C}} = 850\text{ mA}$	4.0	—	—	W
G_{P}^2	$f = 860\text{ MHz}$	$V_{\text{CE}} = 25\text{ V}$	$I_{\text{C}} = 850\text{ mA}$	7.0	—	—	dB
IMD_3^3	$P_{\text{SYNC}} = 4\text{ W}$	$V_{\text{CE}} = 25\text{ V}$	$I_{\text{C}} = 850\text{ mA}$	—	—	-60	dBc
COB	$f = 1\text{ MHz}$	$V_{\text{CB}} = 25\text{ V}$		—	—	20	pF

Note 1: $P_{\text{IN}} = 0.8\text{W}$

Note 2: $P_{\text{OUT}} = 4\text{ W}$

Note 3: Levels relative to $P_{\text{SYNC}} = 4\text{ W}$

$f_1 = 860.0\text{ MHz}$ -8dBc

$f_2 = 863.5\text{ MHz}$ -16dBc

$f_3 = 864.5\text{ MHz}$ -7dBc

TYPICAL PERFORMANCE

POWER OUTPUT vs POWER INPUT

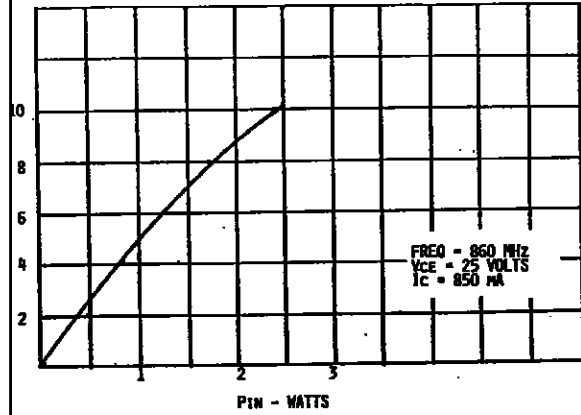

INTERMODULATION DISTORTION vs POWER OUTPUT

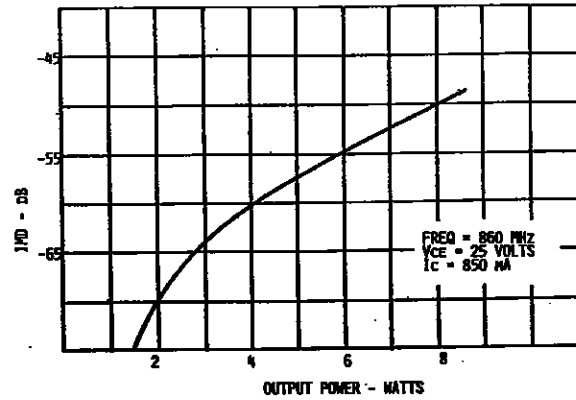

THERMAL RESISTANCE vs CASE TEMPERATURE

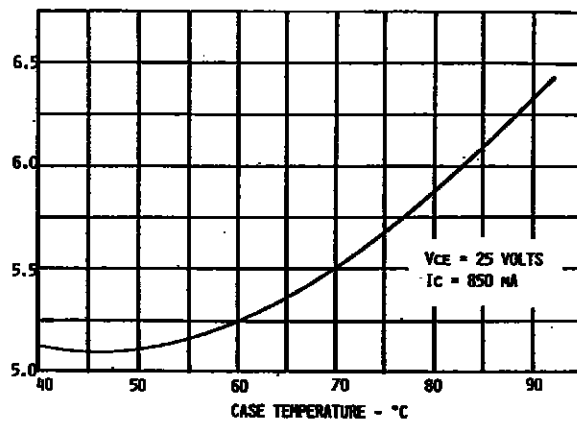

SD1448 (TCC598)

TEST CIRCUIT

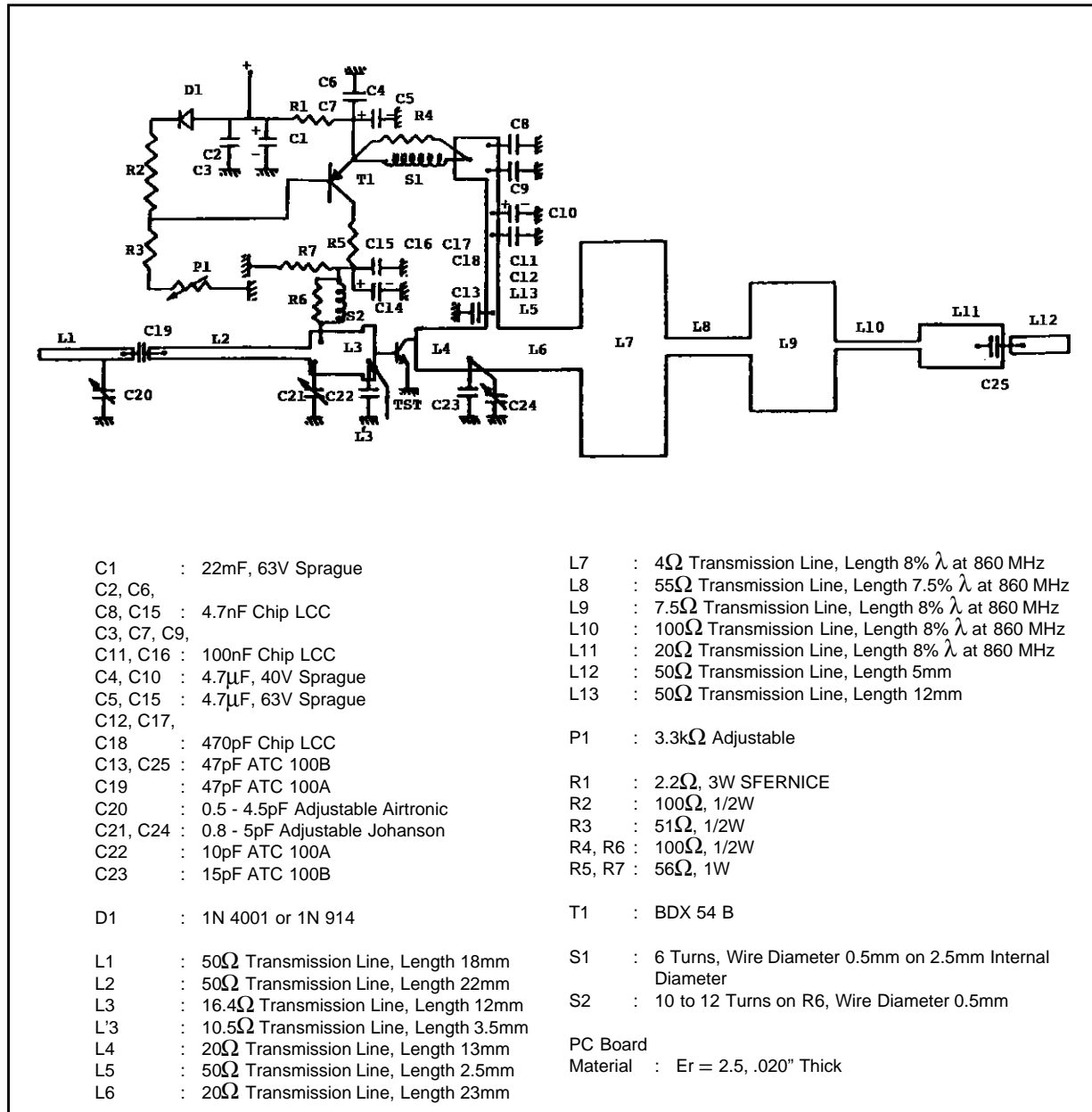

TEST CIRCUIT LAYOUT

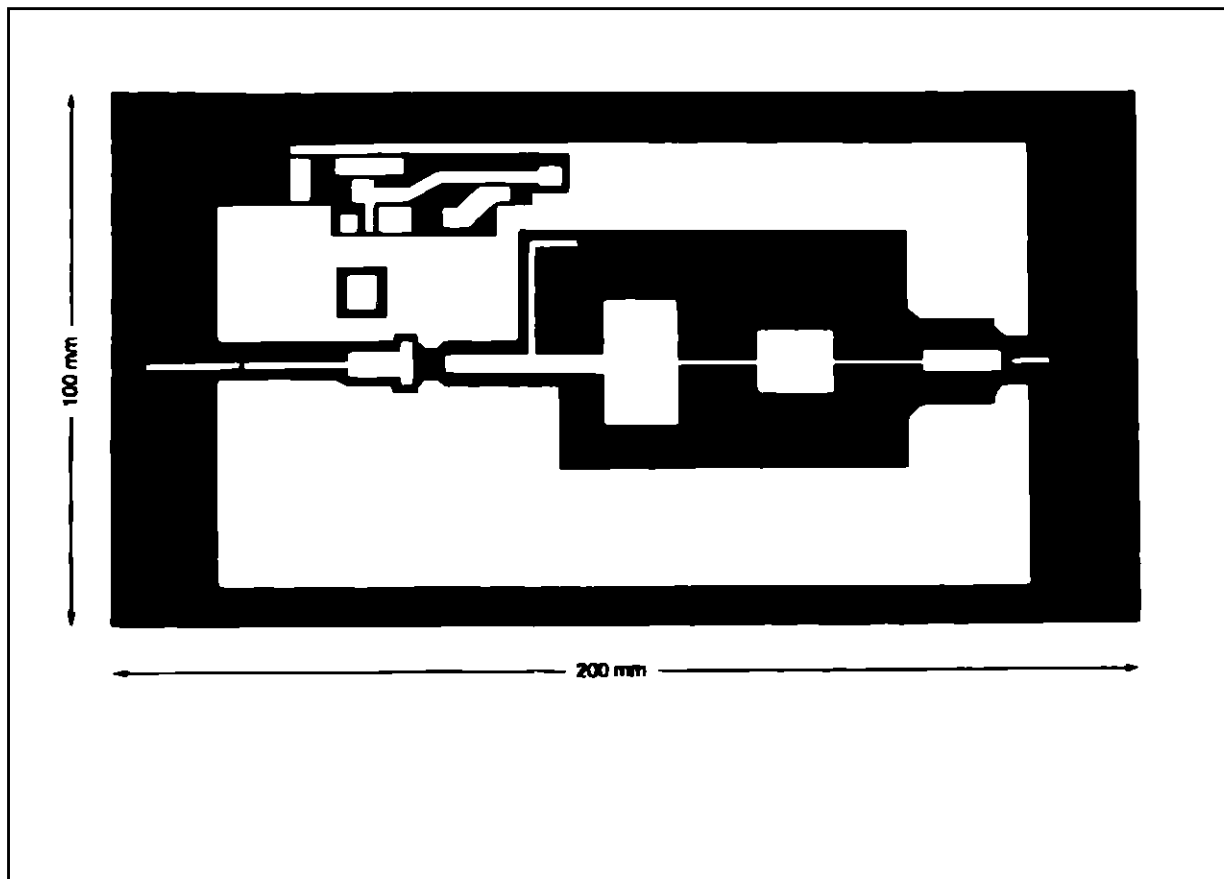

SD1448 (TCC598)

PACKAGE MECHANICAL DATA

Ref.: Dwg. No.12-0122

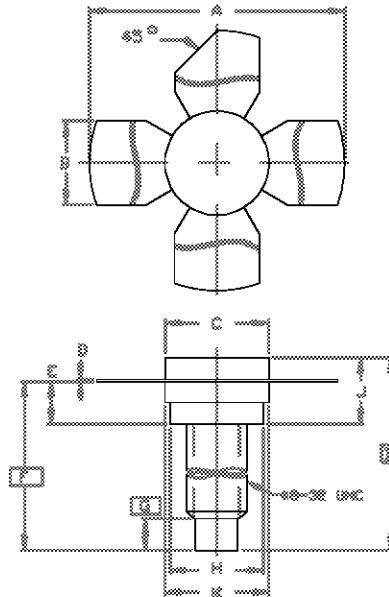

SGS-THOMSON MICROELECTRONICS		
	MINIMUM Inches/mm	MAXIMUM Inches/mm
A	1.018/25.65	1.035/26.00
B	.220/5.59	.230/5.84
C	.270/6.86	.285/7.24
D	.003/0.08	.007/0.18
E	.117/2.97	.127/3.48
F	.578/14.53	
G	.130/3.30	
H	.245/6.22	.255/6.48
I	.640/16.26	
J	.175/4.43	.217/5.51
K	.275/6.99	.285/7.24

Information furnished is believed to be accurate and reliable. However, SGS-THOMSON Microelectronics assumes no responsibility for the consequences of use of such information nor for any infringement of patents or other rights of third parties which may result from its use. No license is granted by implication or otherwise under any patent or patent rights of SGS-THOMSON Microelectronics. Specifications mentioned in this publication are subject to change without notice. This publication supersedes and replaces all information previously supplied. SGS-THOMSON Microelectronics products are not authorized for use as critical components in life support devices or systems without express written approval of SGS-THOMSON Microelectronics.

© 1994 SGS-THOMSON Microelectronics - All Rights Reserved

SGS-THOMSON Microelectronics GROUP OF COMPANIES
 Australia - Brazil - France - Germany - Hong Kong - Italy - Japan - Korea - Malaysia - Malta - Morocco - The Netherlands -
 Singapore - Spain - Sweden - Switzerland - Taiwan - Thailand - United Kingdom - U.S.A